

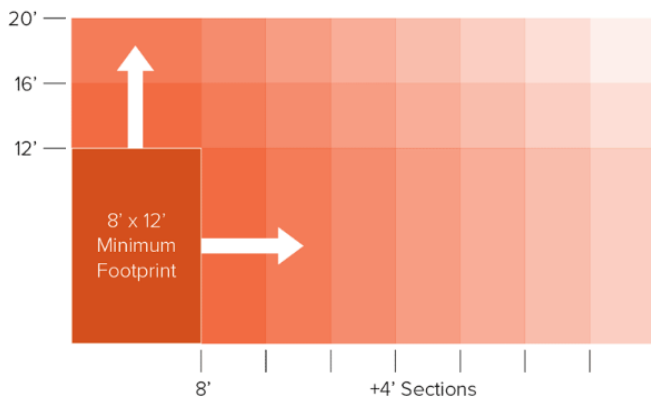

# Cycle Station 2



The Cycle Station 2 provides scalable, high-capacity, secure bike parking for bicycle commuters. With a high roof and open platform, the Cycle Station 2 allows bike corrals, vertical, or two-tiered bike racks configured to meet your specific needs.



The Cycle Station 2 is available in 12', 16' and 20' widths, and can be expanded lengthwise by as many 4' sections as you like, giving you the flexibility to accommodate your capacity requirements, no matter how big or small.

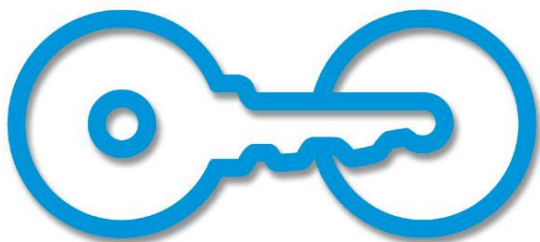

**American Bicycle Security Company**

P.O. Box 7359

Ventura, CA 93006

Ph: (800) 245-3723 or (805) 933-3688

Fax: (805) 933-1865

[www.ameribike.com](http://www.ameribike.com)

Email: [turtle@ameribike.com](mailto:turtle@ameribike.com)

# Cycle Station 2

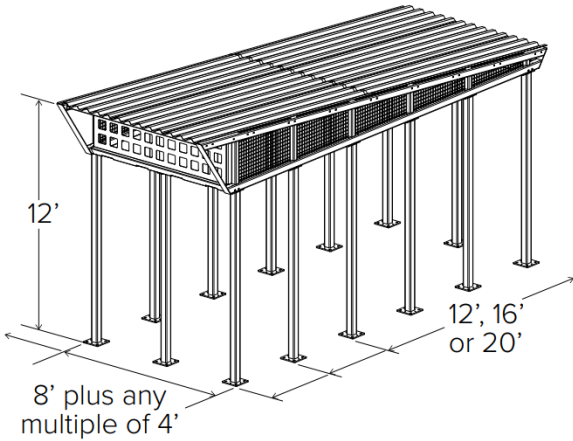

Product Cycle Station 2

Materials Uprights: 4" x 3/16" square tube.  
Base Plates: 1/2" plate  
Roof Truss: 4"x 3" x 1/4" square tube  
Roof Purlins: 3" x 1/8" square tube  
Roof Panels: 24g steel ribbed panel  
Panels: 2" x 1/4" steel wire mesh with 3" steel framing

Installation Methods **Surface Mount.** It is the responsibility of the installer to ensure that all base materials into which the shelter will be installed can support the rack and will not be damaged by any required installation procedures. See structural drawings for details.

Load Data Dead Load: 2.5psf, self-weight of structure  
Live Load: 40 psf  
Wind Load: 96 mph, exposure B, risk category II  
Seismic Risk: Category II  
Footing: see separate page  
Anchors: 5/8" Ø x 4-1/2" embed Simpson Strong-Bolt 2 wedge anchors

Solar powered lights for the shelter exterior are available for an additional charge

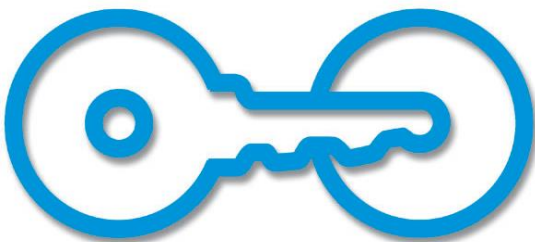
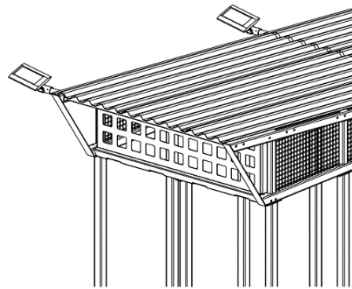

**American Bicycle Security Company**

P.O. Box 7359

Ventura, CA 93006

Ph: (800) 245-3723 or (805) 933-3688

Fax: (805) 933-1865

[www.ameribike.com](http://www.ameribike.com)

Email: [turtle@ameribike.com](mailto:turtle@ameribike.com)

# Cycle Station 2

## Options



**Finish Options:** Galvanized (Roof trusses are galvanized only. Uprights and mesh panels may have a powder coat color or galvanized finish.)



Powder Coated

RAL 9005	Flat Black	RAL 9003	RAL 2004	RAL 1023	Bright Yellow
RAL 6016	RAL 6018	RAL 6005	RAL 5005	RAL 5015	Purple
RAL 7011	RAL 7042	RAL 9007	RAL 1001	RAL 8014	Bronze
RAL 3003	RAL 3005				

**Roofing:** Roof panels are available in a variety of colors.

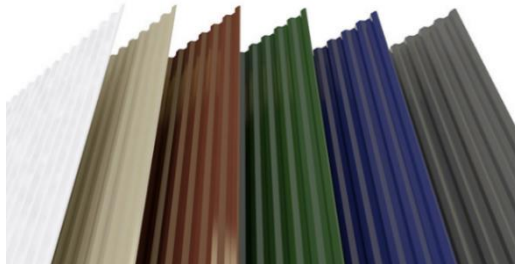

Hawaiian Blue	Crimson Red	Fern Green	Burnished Slate	Cobalt Blue	Charcoal Gray	Light Stone
Ash Gray	Saddle Tan	Desert Sand	Koko Brown	Rustic Red	Polar White	Solar White

**Doors:** Door(s) may be placed between any uprights for greatest flexibility in layout. A standard door includes an electronic strike, exterior keyed handle, interior push bar, and door closer. Access system not included. A variety of door handles, locks, and closers are available per spec.

**Capacities:** Sample capacities for 3 Unit Configurations shown below

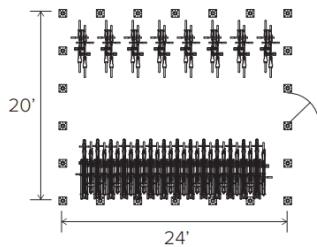

20'x24' Shelter Hoop Racks and Dero Deckers  
**44 Bikes**

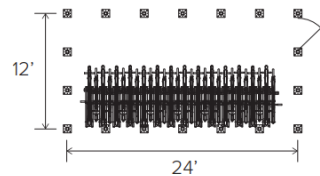

12'x24' Shelter Dero Deckers  
**28 Bikes**

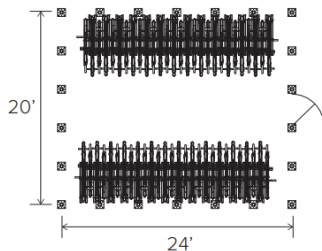

20'x24' Shelter Dero Deckers  
**56 Bikes**

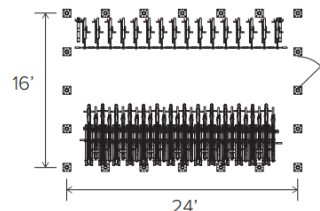

16'x24' Shelter Ultra Space Saver Squared and Dero Deckers  
**44 Bikes**

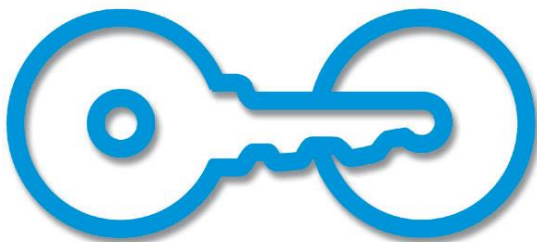

**American Bicycle Security Company**

P.O. Box 7359

Ventura, CA 93006

Ph: (800) 245-3723 or (805) 933-3688

Fax: (805) 933-1865

[www.ameribike.com](http://www.ameribike.com)

Email: [turtle@ameribike.com](mailto:turtle@ameribike.com)

# Cycle Station 2

## Parts List

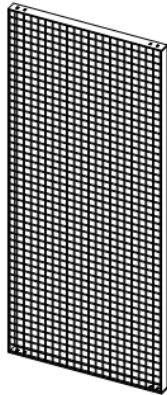

Panel Wire Mesh

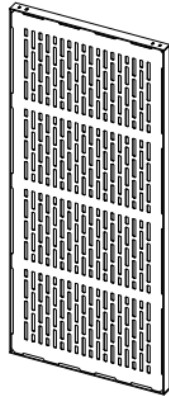

Solid Panel

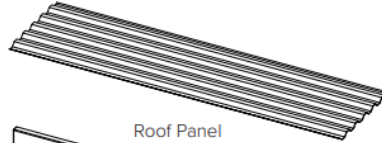

Roof Panel



Panel Bracket

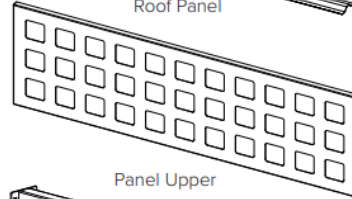

Panel Upper

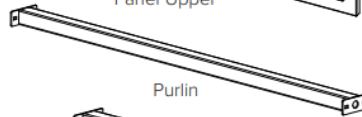

Purlin



Purlin Half

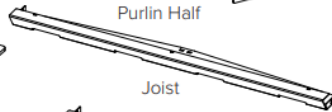

Joist



Joist Half

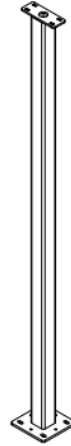

Upright

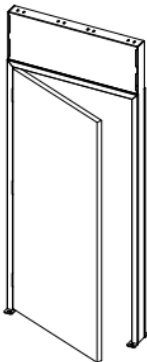

Door Frame

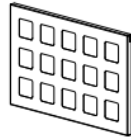

Panel Upper Half



Panel Bracket Offset  
Right and Left

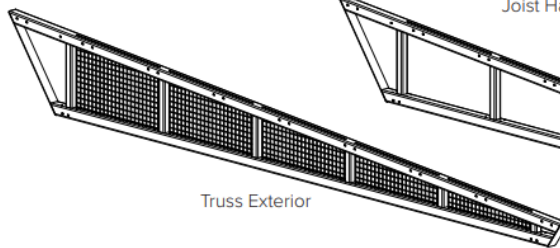

Truss Exterior

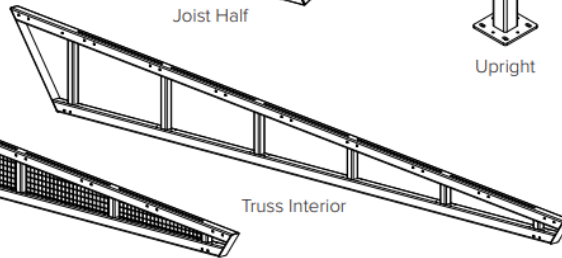

Truss Interior



Carriage Bolt  
3/8 x 1"

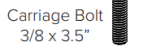

Carriage Bolt  
3/8 x 3.5"

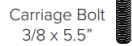

Carriage Bolt  
3/8 x 5.5"



Carriage Bolt  
1/2 x 1"

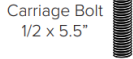

Carriage Bolt  
1/2 x 5.5"

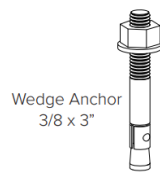

Wedge Anchor  
3/8 x 3"

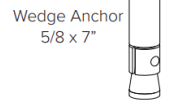

Wedge Anchor  
5/8 x 7"



3/8" Lock Washer

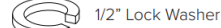

1/2" Lock Washer



3/8" Washer



3/8" Nut



1/2" Nut



3/8" Penta Nut

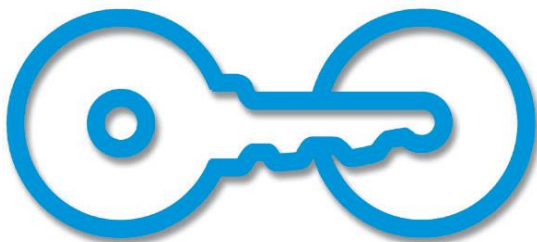

**American Bicycle Security Company**

P.O. Box 7359

Ventura, CA 93006

Ph: (800) 245-3723 or (805) 933-3688

Fax: (805) 933-1865

[www.ameribike.com](http://www.ameribike.com)

Email: [turtle@ameribike.com](mailto:turtle@ameribike.com)

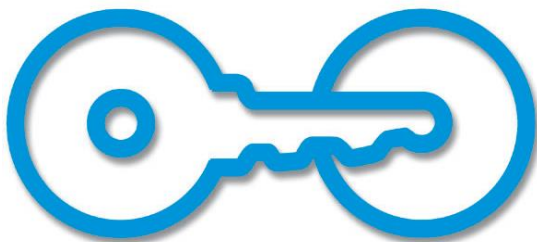
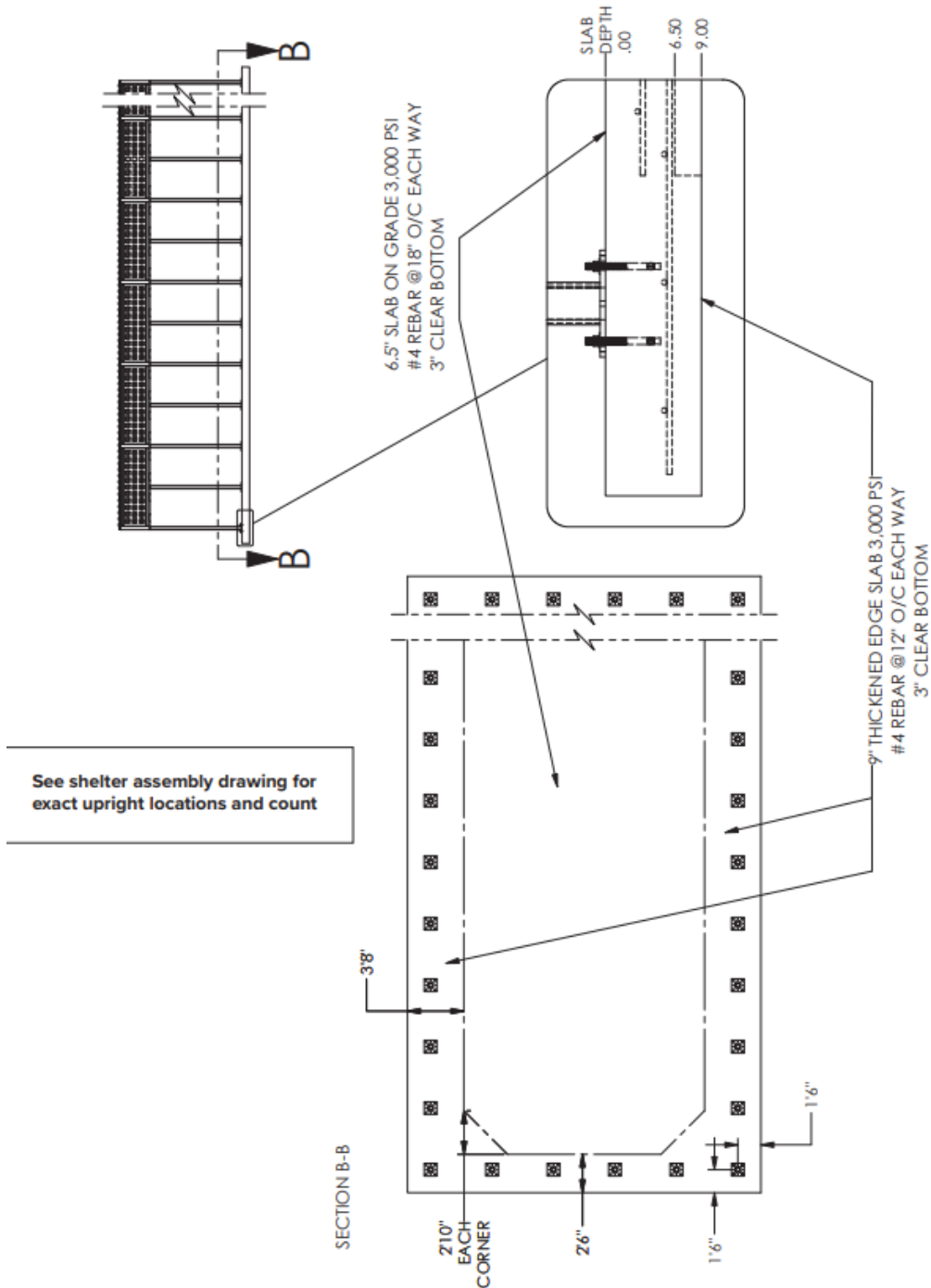

**American Bicycle Security Company**

P.O. Box 7359

Ventura, CA 93006

Ph: (800) 245-3723 or (805) 933-3688

Fax: (805) 933-1865

[www.ameribike.com](http://www.ameribike.com)

Email: [turtle@ameribike.com](mailto:turtle@ameribike.com)



### Tools Needed:

- |                          |   |
|--------------------------|---|
| Hammer Drill             | Forklift  |
| Masonry Bits: 3/8", 5/8" | Wrenches: 9/16", 3/4", 15/16"                   |
| Large Hammer             | Socket Wrench with Sockets: 9/16", 3/4", 15/16" |
| Level                    | Drill   |
| Chalk Line               | Nut Driver: 5/16"                               |
| Tape Measure             | Metal Shears (up to 24g steel)                  |
| Tall Ladders             |   |

- Place uprights on concrete foundation (see foundation design drawing). Confirm all uprights are properly spaced and square. All upright should be at the same elevation; use non-shrink grout risers if needed. Longer anchors may be needed to maintain minimum 5/8" concrete embedment. Using the upright base as a template, drill (4) 5/8" diameter holes at each upright. Install wedge anchors with a minimum embedment of 4 5/8". Add nuts and washers and leave finger tight. See shelter assembly drawing for specific upright placement locations.
- Lift trusses into place and fasten to uprights every 8' with (4) 1/2" x 5 1/2" carriage bolts, lock washers, and nuts at each upright. Leave finger-tight.

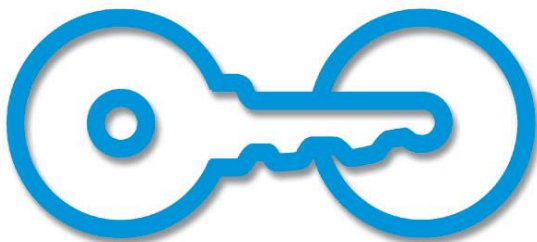
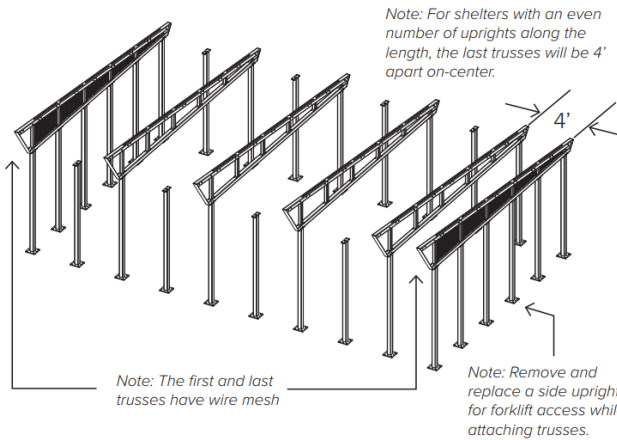
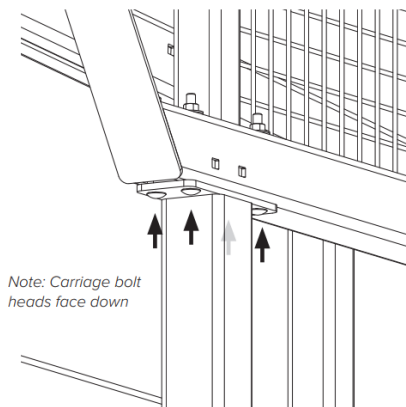
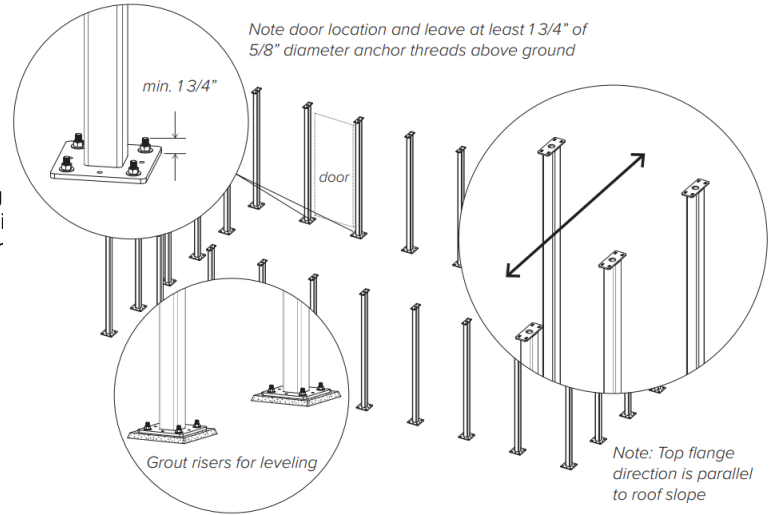

**American Bicycle Security Company**

P.O. Box 7359

Ventura, CA 93006

Ph: (800) 245-3723 or (805) 933-3688

Fax: (805) 933-1865

[www.ameribike.com](http://www.ameribike.com)

Email: [turtle@ameribike.com](mailto:turtle@ameribike.com)

# Cycle Station 2

## Installation Instructions



3. Attach the joists with (2) 1/2" x 5 1/2" carriage bolts, lock washers and nuts at both ends. Attach the joist to the middle upright with (4) 1/2" x 1 1/2" carriage bolts, lock washers and nuts. Leave finger-tight.

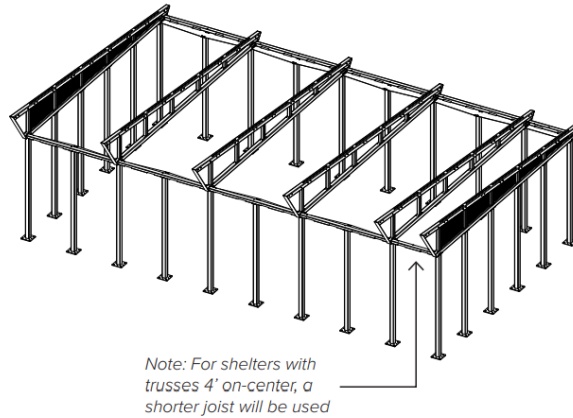
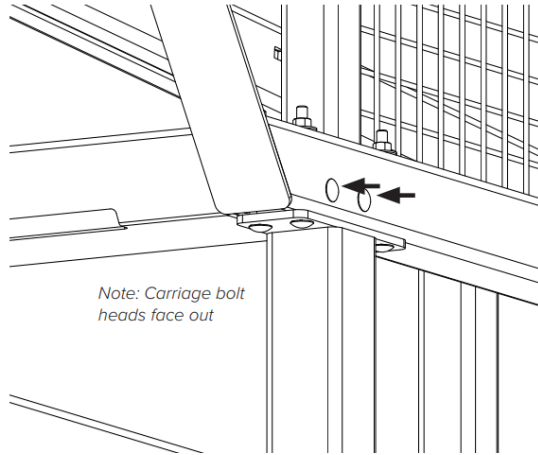

4. Attach the purlins with (2) 1/2" x 5 1/2" carriage bolts, lock washers and nuts at both ends. Leave finger-tight.

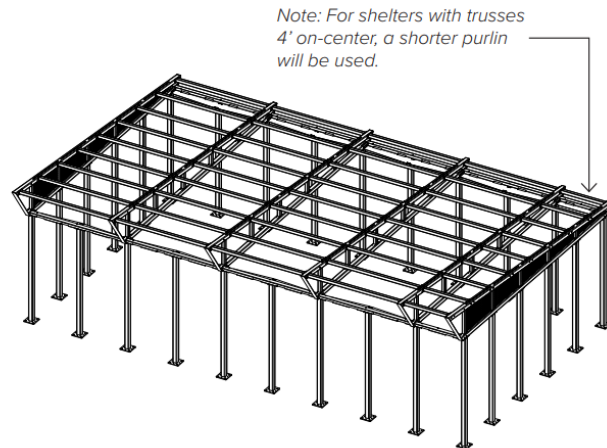
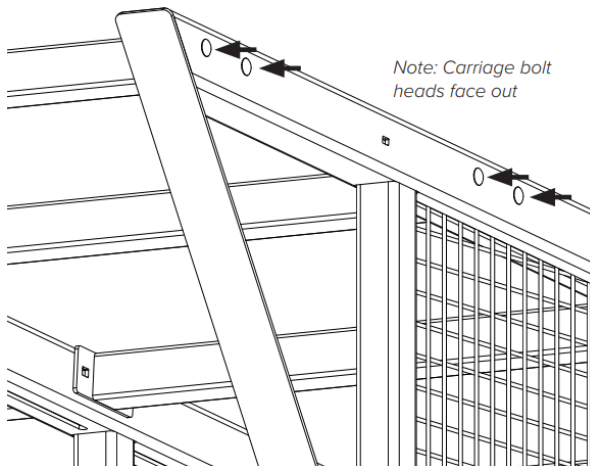

5. Tighten all fasteners:
- Confirm spacing of upright bases and tighten wedge anchors. All uprights are 48" on-center.
  - Tighten bolts at upright tops and trusses.
  - Tighten bolts at purlins and trusses.
  - Tighten bolts at joist ends and trusses.
  - Tighten bolts at remaining upright tops and joists.

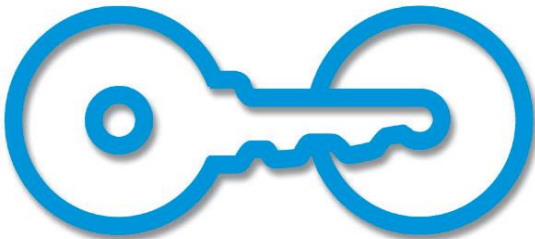

**American Bicycle Security Company**

P.O. Box 7359

Ventura, CA 93006

Ph: (800) 245-3723 or (805) 933-3688

Fax: (805) 933-1865

[www.ameribike.com](http://www.ameribike.com)

Email: [turtle@ameribike.com](mailto:turtle@ameribike.com)



6. Attach the upper panels to the trusses with (2) 3/8" x 5 1/2" carriage bolts, lock washers and nuts at both top ends. Attach to the joists with (3) 3/8" x 1" carriage bolts, lock washers and nuts at bottom.

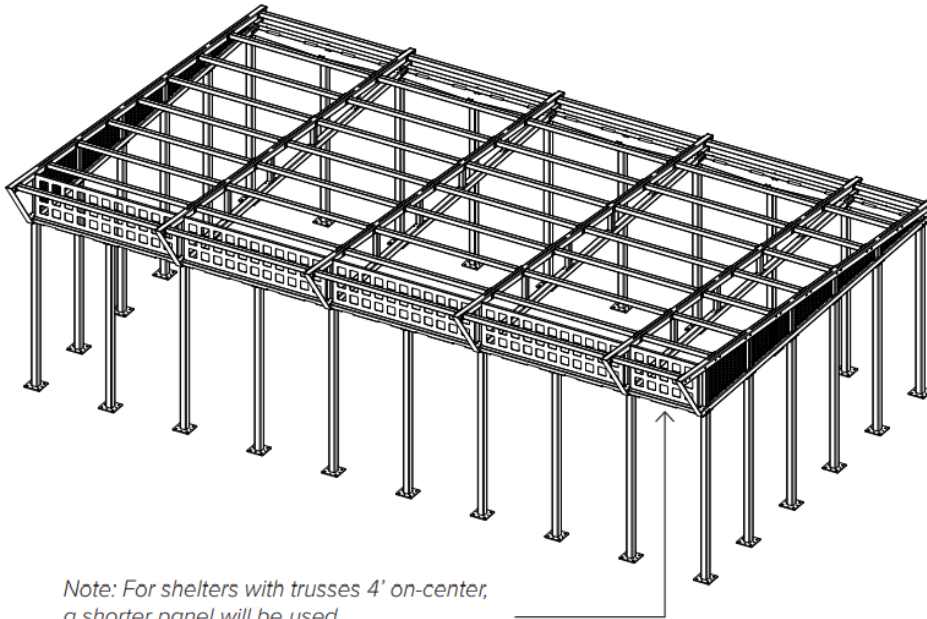

7. Attach roof panels with manufacturer's instructions.

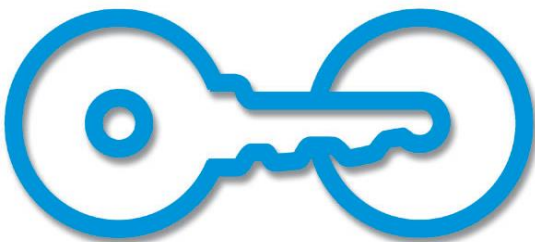
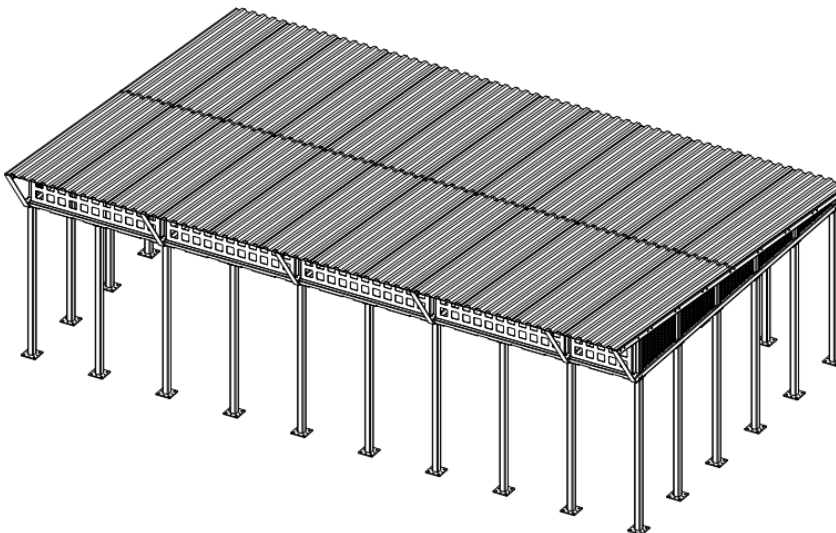

**American Bicycle Security Company**

P.O. Box 7359

Ventura, CA 93006

Ph: (800) 245-3723 or (805) 933-3688

Fax: (805) 933-1865

[www.ameribike.com](http://www.ameribike.com)

Email: [turtle@ameribike.com](mailto:turtle@ameribike.com)





1. At every location a panel is to be installed, drill a 3/8" dia. hole in the concrete through the existing hole in the upright base. Attach the panel brackets with a 3/8" x 3" wedge anchor.

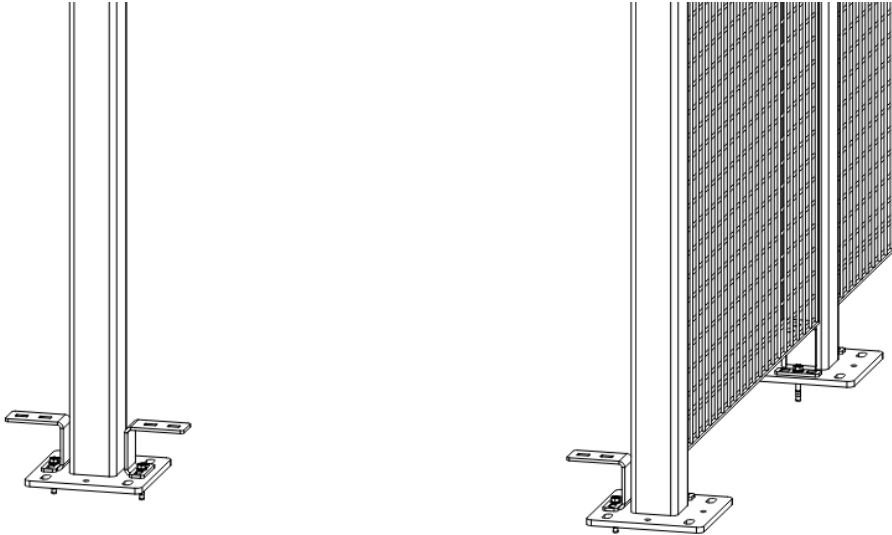

2. At every location a panel is to be installed on the front or back of the shelter, remove the (2) outer carriage bolts at the top of the uprights and add the offset panel brackets below the upright flanges with the same carriage bolts. The offset brackets angle towards the shelter.

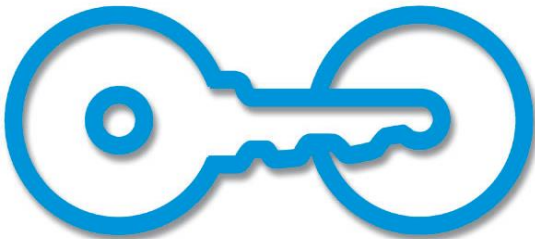
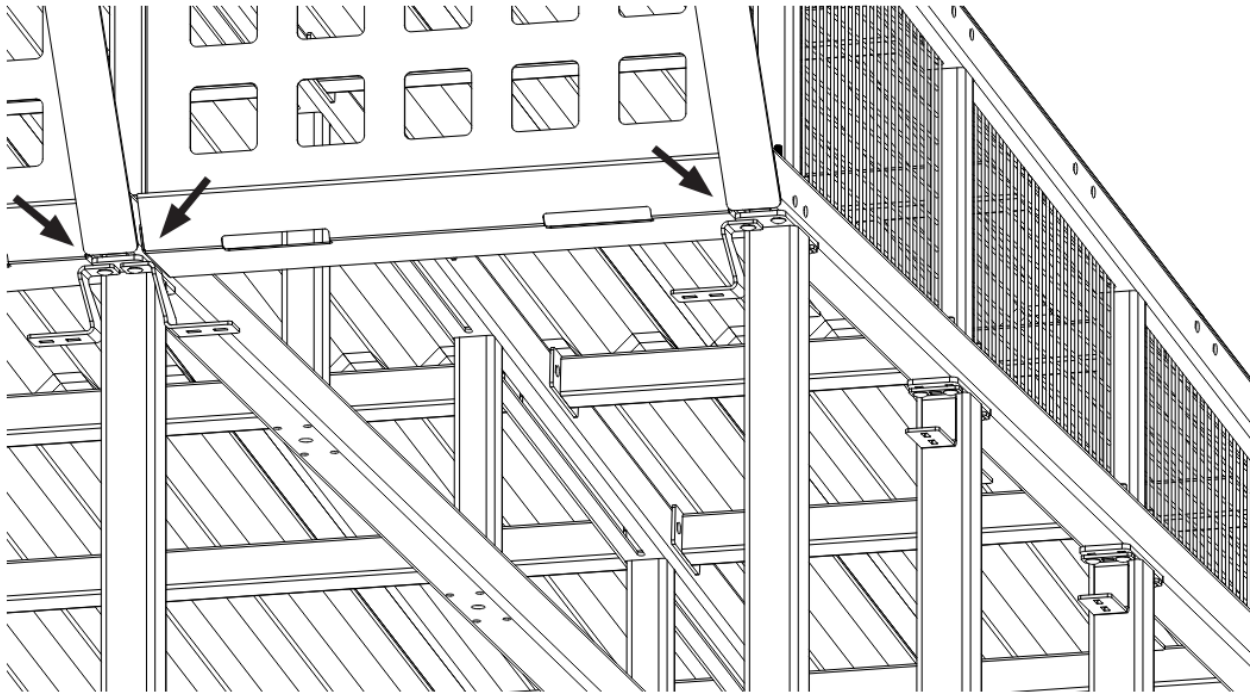

**American Bicycle Security Company**

P.O. Box 7359

Ventura, CA 93006

Ph: (800) 245-3723 or (805) 933-3688

Fax: (805) 933-1865

[www.ameribike.com](http://www.ameribike.com)

Email: [turtle@ameribike.com](mailto:turtle@ameribike.com)



3. At every location a panel is to be installed on the sides of the shelter, remove the (4) inner carriage bolts at the top of the uprights and add the panel brackets below the upright flanges with the same carriage bolts.

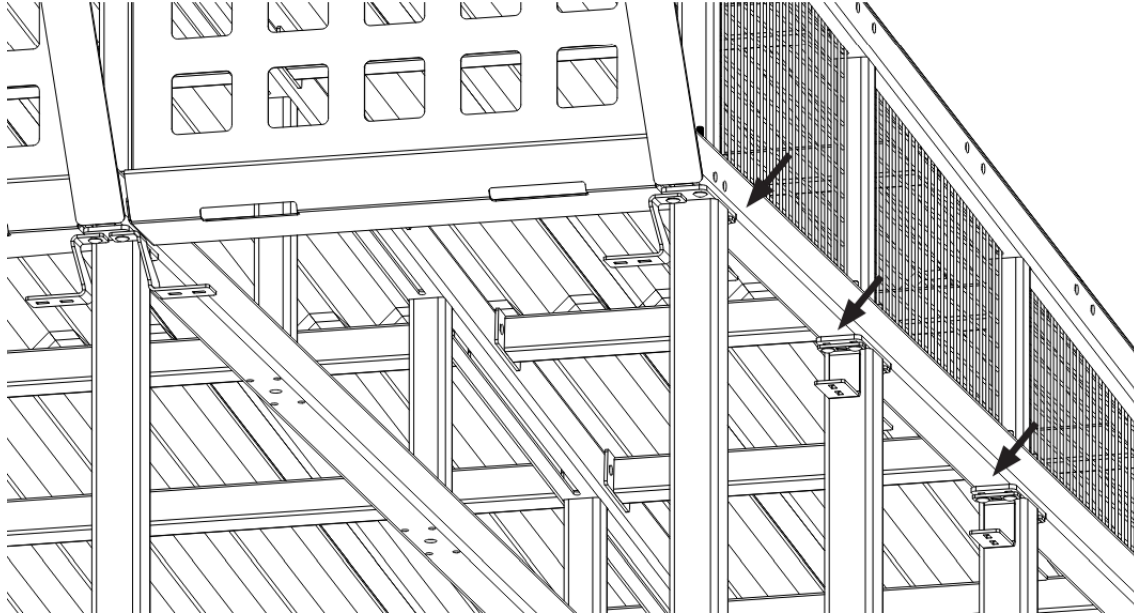

4. Attach panels to each bracket with (2) 3/8" x 1" carriage bolts, washers and nuts. (1) Nut at each bracket will be a Penta nut for security. There are (4) brackets per panel. Typically, the panels adjacent to the door(s) will be solid for extra security. Consult the job specific plan for more detail.

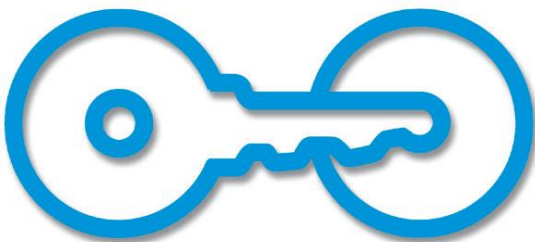
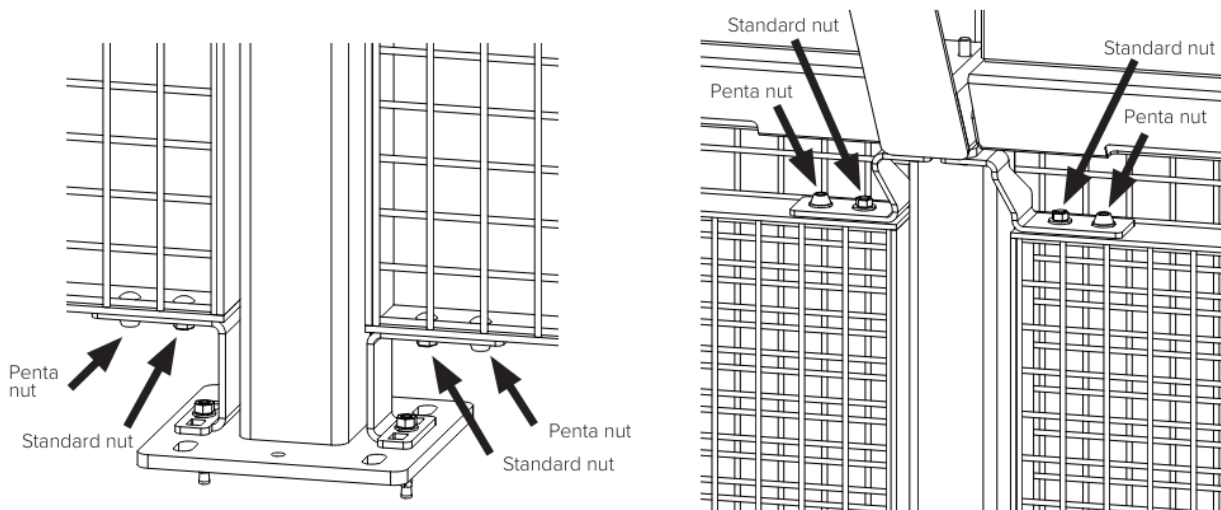

**American Bicycle Security Company**

P.O. Box 7359

Ventura, CA 93006

Ph: (800) 245-3723 or (805) 933-3688

Fax: (805) 933-1865

[www.ameribike.com](http://www.ameribike.com)

Email: [turtle@ameribike.com](mailto:turtle@ameribike.com)



### Front or Back Doors:

- A) At every location a door is to be installed on the front or back of the shelter, remove the (2) outer carriage bolts at the top of the uprights and add the offset panel brackets below the upright flanges with the same carriage bolts. The offset brackets angle towards the shelter.

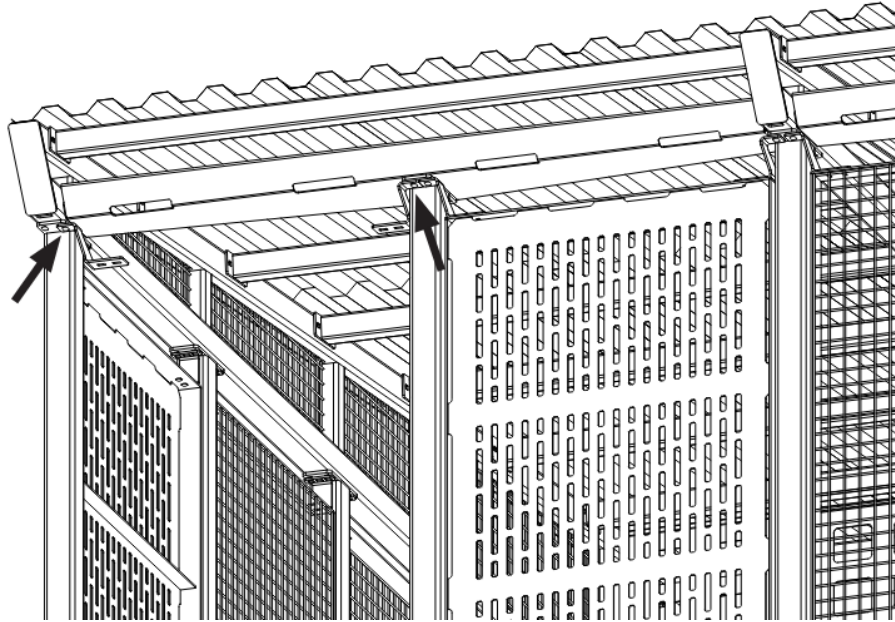

- B) Below these panel brackets, remove the (4) inner 5/8" wedge anchor nuts and washers at the base of the uprights.  
C) Attach the bottom of the door frame to the upright bases with the 5/8" wedge anchor nuts and washers.

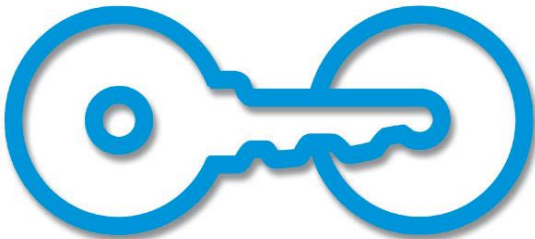
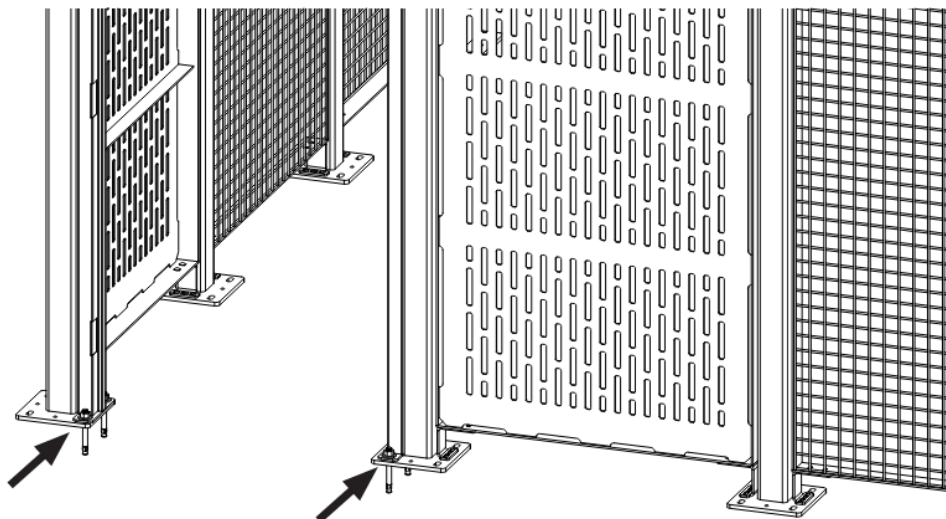

**American Bicycle Security Company**

P.O. Box 7359

Ventura, CA 93006

Ph: (800) 245-3723 or (805) 933-3688

Fax: (805) 933-1865

[www.ameribike.com](http://www.ameribike.com)

Email: [turtle@ameribike.com](mailto:turtle@ameribike.com)



- D) Attach the top of the door frame to each bracket with (2) 3/8" x 1" carriage bolts, washers and nuts. (1) Nut at each bracket will be a Penta nut for security.

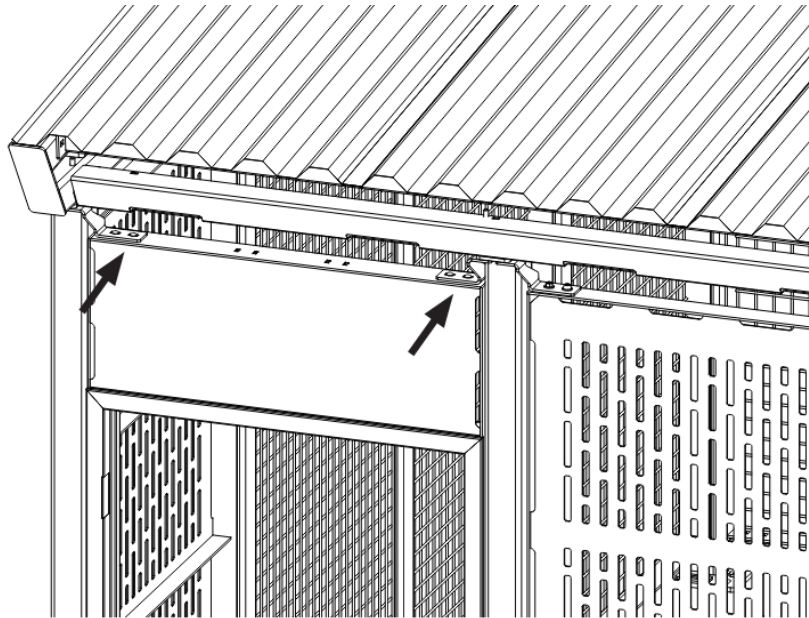

- E) Attach the door and hinges to door frame with supplied hardware.

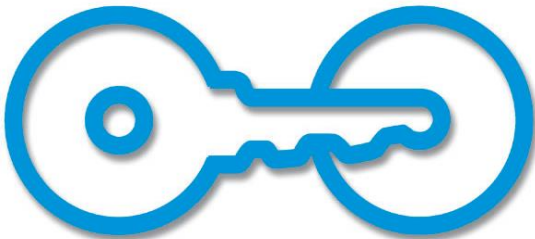
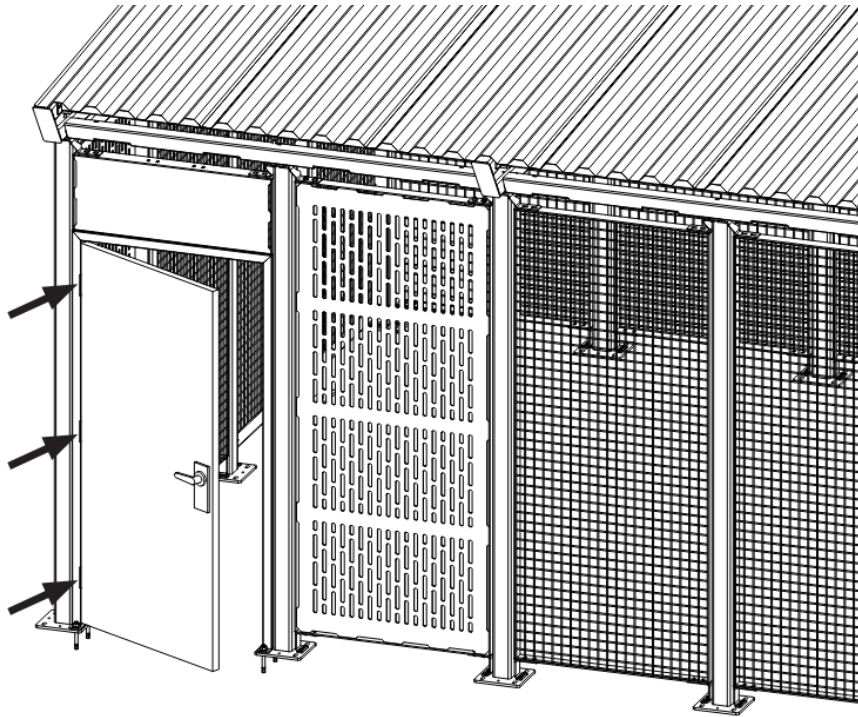

**American Bicycle Security Company**

P.O. Box 7359

Ventura, CA 93006

Ph: (800) 245-3723 or (805) 933-3688

Fax: (805) 933-1865

[www.ameribike.com](http://www.ameribike.com)

Email: [turtle@ameribike.com](mailto:turtle@ameribike.com)



### Side Doors:

- A) At every location a door is to be installed on the sides of the shelter, remove the (4) inner carriage bolts at the top of the uprights and add the panel brackets below the upright flanges with the same carriage bolts.

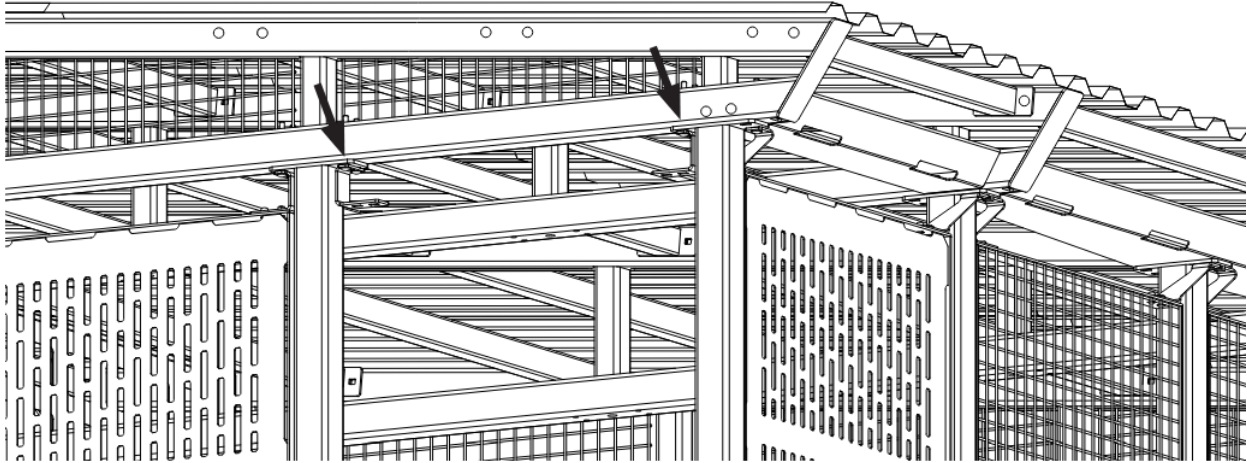

- B) Below these panel brackets, remove the (4) inner 5/8" wedge anchor nuts and washers at the base of the uprights.  
C) Attach the bottom of the door frame to the upright bases with the 5/8" wedge anchor nuts and washers.

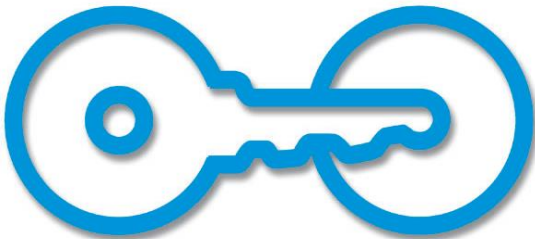
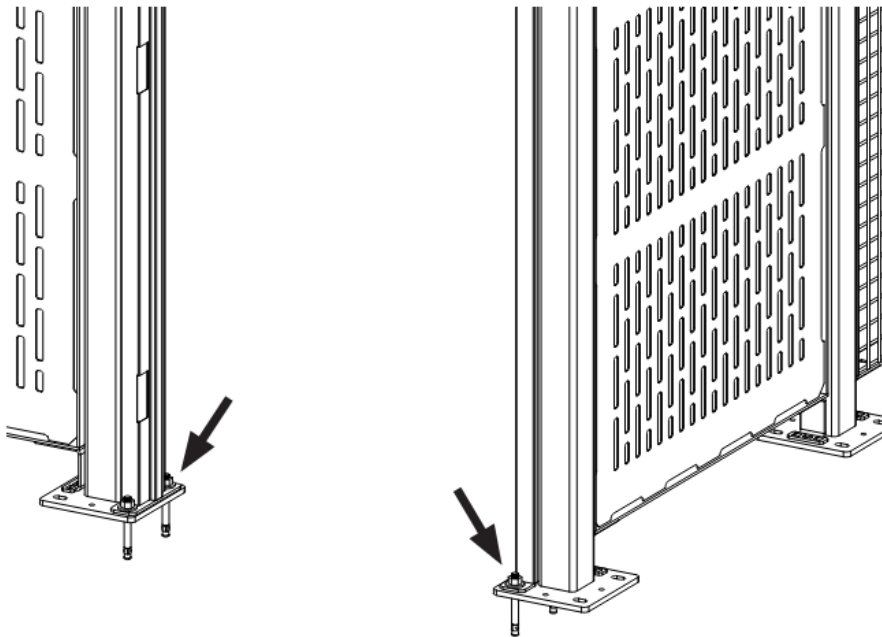

**American Bicycle Security Company**

P.O. Box 7359

Ventura, CA 93006

Ph: (800) 245-3723 or (805) 933-3688

Fax: (805) 933-1865

[www.ameribike.com](http://www.ameribike.com)

Email: [turtle@ameribike.com](mailto:turtle@ameribike.com)



- D) Attach the top of the door frame to each bracket with (2) 3/8" x 1" carriage bolts, washers and nuts. (1) nut at each bracket will be a Penta nut for security

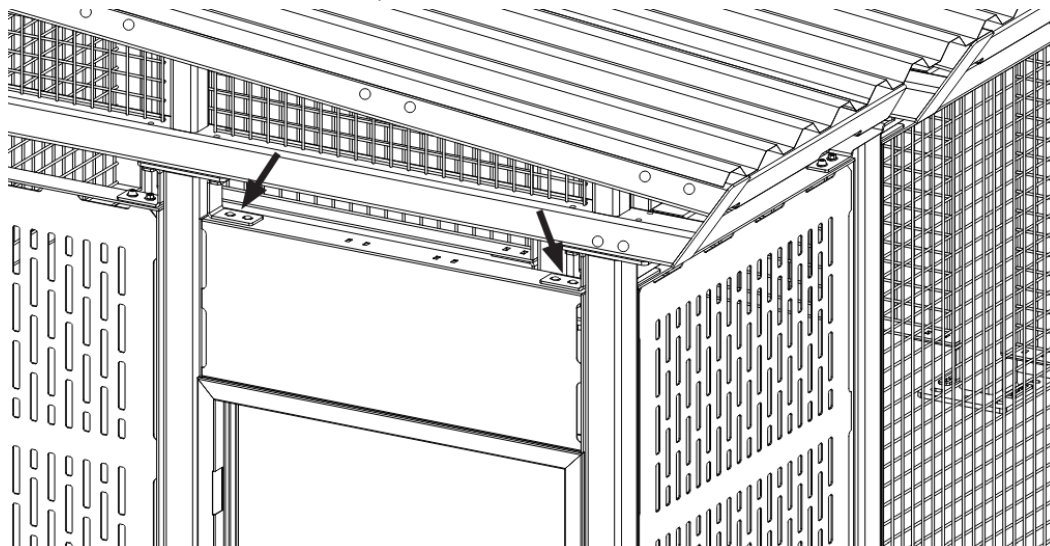

- E) Attach the door and hinges to door frame with supplied hardware.

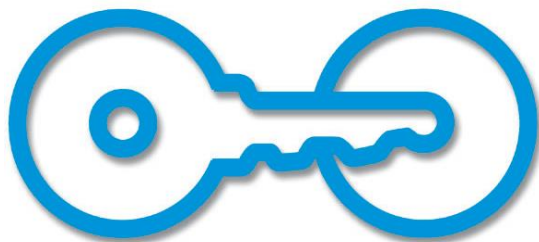
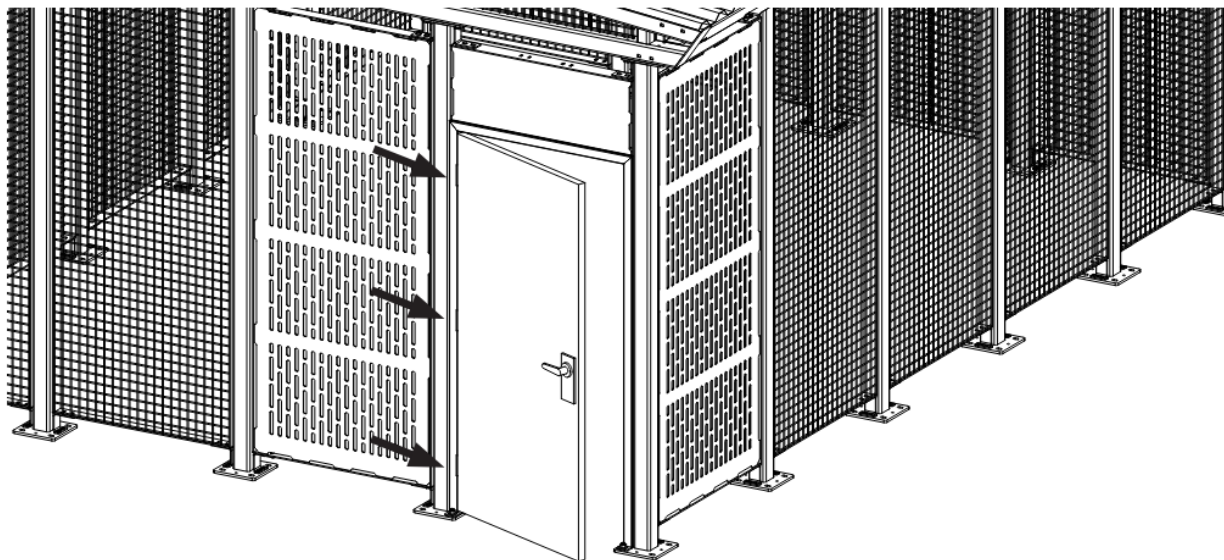

**American Bicycle Security Company**

P.O. Box 7359

Ventura, CA 93006

Ph: (800) 245-3723 or (805) 933-3688

Fax: (805) 933-1865

[www.ameribike.com](http://www.ameribike.com)

Email: [turtle@ameribike.com](mailto:turtle@ameribike.com)